

Stilt

descriptif technique



.mdd

.mdd, créée en 1993 à Sępólno Krajeńskie en Pologne, est d'abord une histoire d'amitié entre Jaroslaw DABROWSKI et Zbigniew MATTYA.

Depuis l'origine, nous souhaitons incarner un modèle d'entreprise où l'humain est la première des préoccupations. Nous considérons que l'épanouissement personnel de chaque membre de notre équipe, est la clé de notre succès. Garder comme piliers des valeurs familiales participe à ce projet.

Nous créons du mobilier répondant aux besoins spécifiques des espaces de travail. Pour vous permettre de favoriser le travail collaboratif, la créativité et les échanges dans l'entreprise, nous vous proposons un mobilier design, conçu PAR et POUR l'homme. Grâce à notre politique de réinvestissement constant dans l'outil de production nous disposons d'un parc de machines modernes, permettant une fabrication de qualité. Citoyens du monde, nous agissons aujourd'hui en pensant aux générations de demain. Ainsi nous utilisons des matériaux au taux de recyclabilité proche de 95%.

Le monde du travail est en mutation constante. Nous veillons, et collaborons avec des designers et nos clients, pour anticiper et être toujours au plus près du besoin.



Informations générales :

Garantie :

Produits .mdd - **5 ans.**

Composants électriques et tissus - **2 ans.**

Certyfikat - płyta melaminowana:



Tissus - certifié :



Montage :

le produit est livré pré-assemblé

Emballage :

film mousse, carton

Stilt	Date 27.10.2021	Ces données sont valides à la date d'élaboration. Les évolutions des produits, si elles ne touchent pas les caractéristiques fondamentales, n'impliquent pas une mise à jour systématique de la fiche technique.	page 2/13
			informations générales

Stilt - fauteuil, canapé

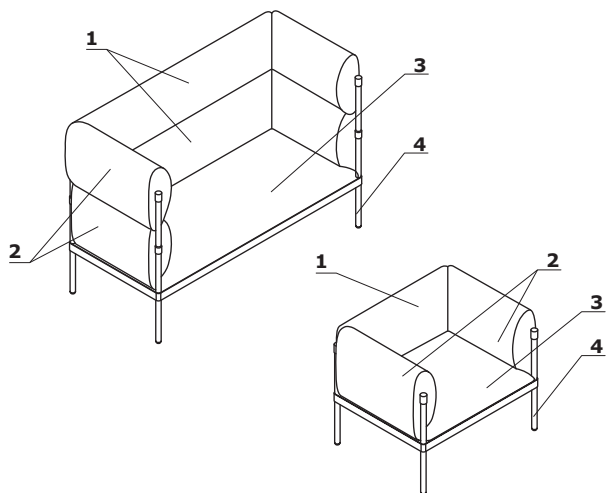

1. **Dossier** - structure en panneaux de particules de 18 mm d'ép.; mousse découpée, densité de 25 kg/m³; tapissée
2. **Accoudoirs** - structure en panneaux de particules de 18 mm d'ép.; mousse découpée, densité de 40 kg/m³; tapissée
3. **Assise** - ossature en acier avec ressorts; mousse découpée, densité de 35 kg/m³; tapissée
4. **Base** - 4 pieds, finition peinture poudre époxy; pieds tubes diamètre Ø 30 mm, ep. 2 mm

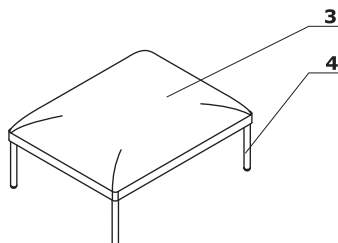

Accessoires - fauteuil, canapé

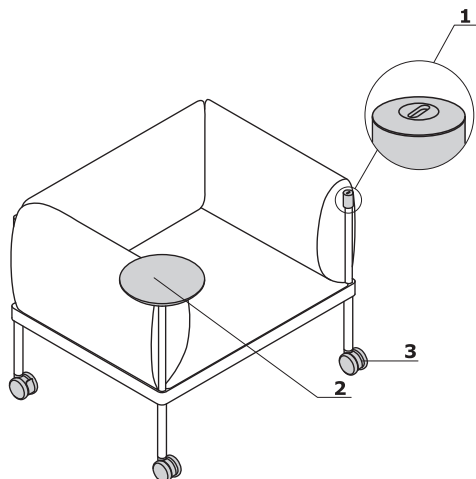

OPTION PAYANTE :

1. **Mediabox M010** - USB A, C; 5V, 2x2,5 Amp
2. **Plateau** - MDF laqué 19 mm - assortis à la couleur du piétement; métal finition peinture poudre époxy
3. **Roulettes** - Ø 75 mm

Stilt - rangements ouverts

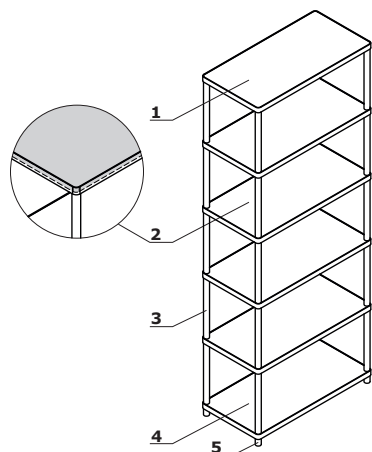

1. **Top** - panneau MDF verni de 19 mm d'ép. avec cadre en métal (3x50 mm)
2. **Tablette** - panneau MDF verni de 19 mm d'ép. avec cadre en métal (3x50 mm)
3. **Tube acier** - finition peinture poudre époxy, Ø30 mm, ep. 2 mm
4. **Base** - panneau MDF verni de 19 mm d'ép. avec cadre en métal (3x50 mm)
5. **Vérins de réglage** - hauteur 14mm, en polyéthylène, couleur : noir ou gris

Dimensions - fauteuil, canapé

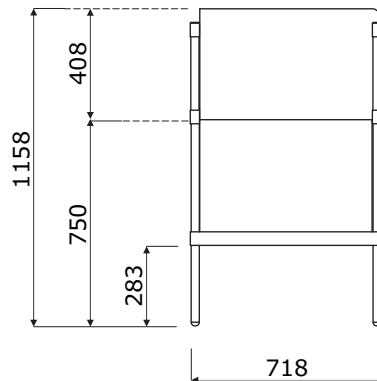
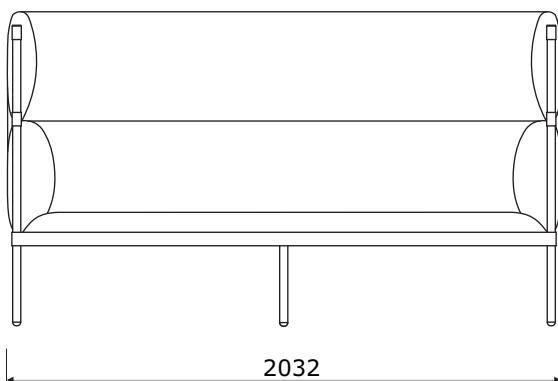
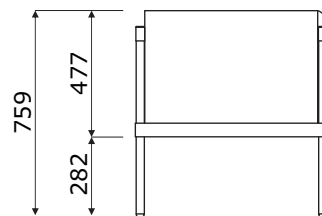
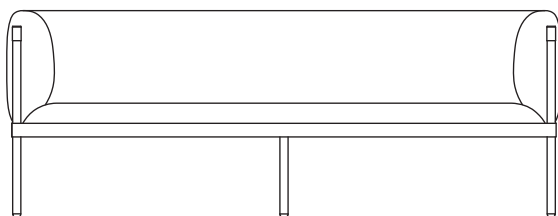
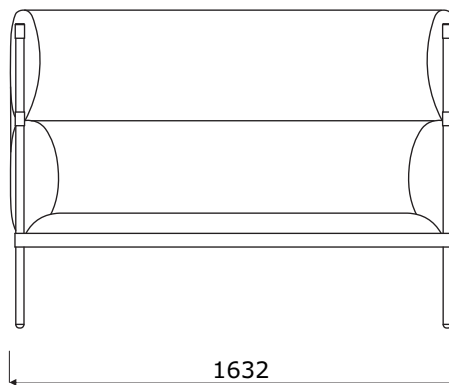
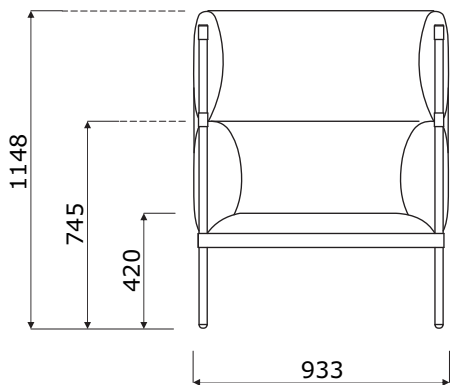
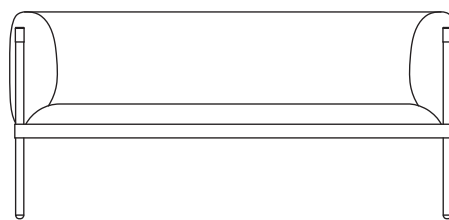
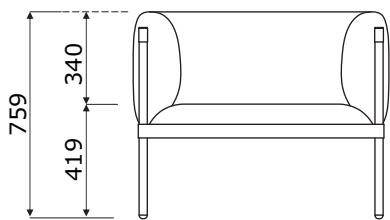

Dimensions - pouf

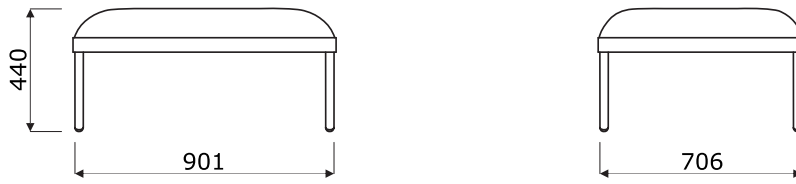

Stilt	Date 27.10.2021	Ces données sont valides à la date d'élaboration. Les évolutions des produits, si elles ne touchent pas les caractéristiques fondamentales, n'impliquent pas une mise à jour systématique de la fiche technique.	page 5/13
			dimensions (mm)

Dimensions - rangements ouverts

SIR5

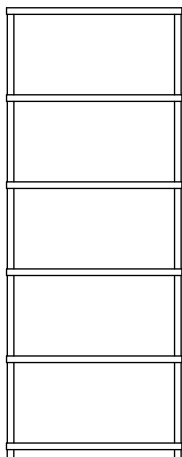

SIR25

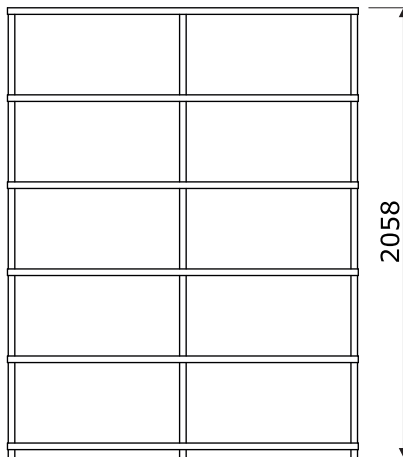

SIR4

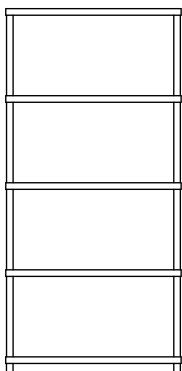

SIR24

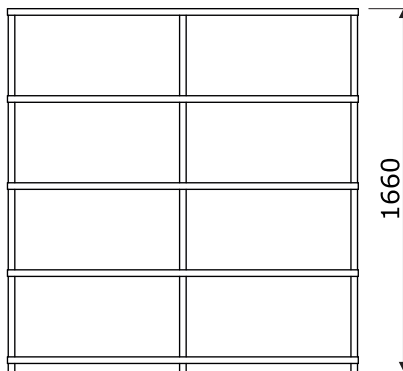

SIR3

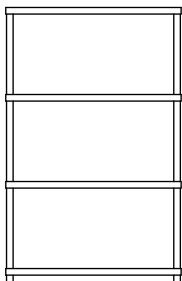

SIR23

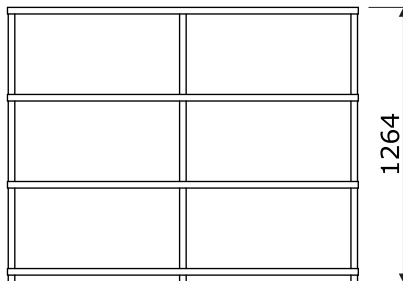

SIR2

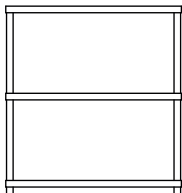

SIR22

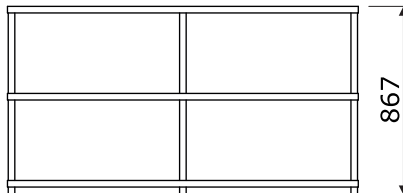

SIRS1

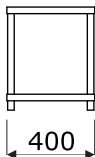

SIR1

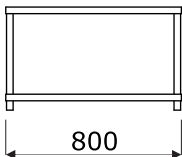

SIR21

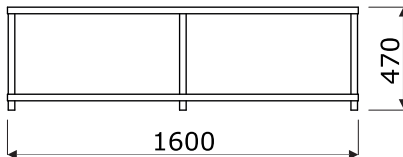

Stilt - fauteuil, canapé *

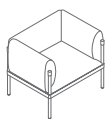

SIS1
932 / 718 / 758
36 kg

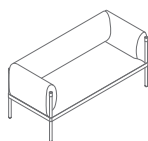

SIS2
1632 / 718 / 758
51.3 kg

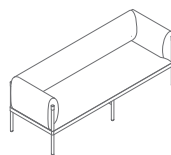

SIS3
2032 / 718 / 758
61.5 kg

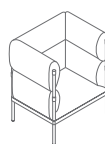

SISH1
932 / 718 / 1158
51.9 kg

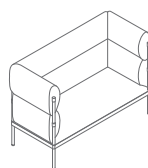

SISH2
1632 / 718 / 1158
72.1 kg

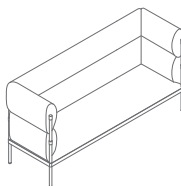

SISH3
2032 / 718 / 1158
55 kg

Stilt - pouf *

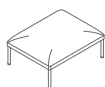

SIS4
901 / 706 / 441
36 kg

* Dimensions exprimées en millimètre : Largeur x Profondeur x Hauteur

Stilt	Date 27.10.2021	Ces données sont valides à la date d'élaboration. Les évolutions des produits, si elles ne touchent pas les caractéristiques fondamentales, n'impliquent pas une mise à jour systématique de la fiche technique.	page 7/13
			synoptique

Stilt - rangements ouverts *



SIRS1
400 / 400 / 470
10.9kg



SIR1
800 / 400 / 470
17.4 kg

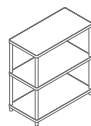

SIR2
800 / 400 / 867
26.6 kg

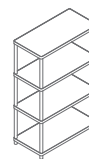

SIR3
800 / 400 / 1264
36.7 kg

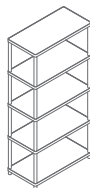

SIR4
800 / 400 / 1660
46 kg



SIR5
800 / 400 / 2058
55.2 kg

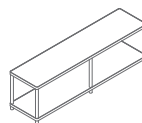

SIR21
1600 / 400 / 470
31 kg

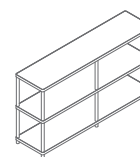

SIR22
1600 / 400 / 867
47.6 kg

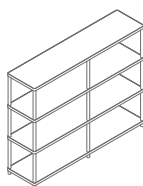

SIR23
1600 / 400 / 1264
63.9 kg

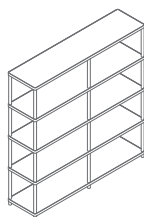

SIR24
1600 / 400 / 1160
80.6 kg

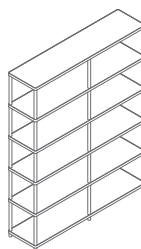

SIR25
1600 / 400 / 2058
96.9 kg

* Dimensions exprimées en millimètre : Largeur x Profondeur x Hauteur

Fauteuil, canapé - assise, appui tete

Tissu Medley - Tarif Groupe II

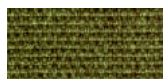

M-68005 Olive foncée

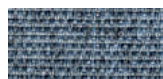

M-66008 Gris



M-64019 Rouge



M-63064 Rose



M-60999 Noir



M-61189 Beige



M-60003 Gris clair



M-62054 Moutarde



M-62002 Jaune



M-66010 Bleu



M-65011 Gris-violet



M-63017 Rouille



M-67006 Bleu clair

Données techniques :

Composition	polyester 100%
Poids du tissu	510 g/lm (16.45 oz/lin.yd.)
Résistance à l'abrasion	BS EN ISO 12947-2, 75,000 Martindale
Résistance au boulochage	scale 1-5, max. 5, EN ISO 12945-2 (4)
Tenue à la lumière	scale 1-8, max. 8, EN ISO 105-B02 (5-7)
Résistance au frottement	scale 1-5, max. 5, EN ISO 105x12 (humide/sec (4-5/4-5))
Absorption acoustique	ISO 354
Normes au feu	BS EN 1021-1 (cigarette) BS 476 Class 2 Class Uno UNI 9174 - UNI 8457 CA TB 117-2013 ASTM E 84 Class I

Tissu Atlantic * - Tarif Groupe II



A-67043 Bleu vert foncé



A-67030 Aigue marine



A-60141 Gris clair

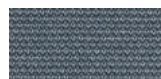

A-60011 Gris



A-66064 Bleu marine

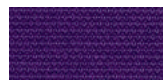

A-65037 Violet

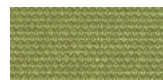

A-62048 Olive

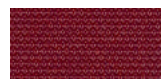

A-64089 Rouge



A-61078 Beige



A-60025 Graphite

Données techniques :

Composition	polyester 100%
Poids du tissu	530 g/lm (17.09 oz/lin.yd.)
Résistance à l'abrasion	BS EN ISO 12947-2, 110,000 Martindale
Résistance au boulochage	scale 1-5, max. 5, EN ISO 12945-2 (4-5)
Tenue à la lumière	scale 1-8, max. 8, EN ISO 105-B02 (5-7)
Résistance au frottement	scale 1-5, max. 5, EN ISO 105x12 (humide/sec (4-5/4-5))
Normes au feu	CA TB 117-2013 ASTM E 84 Class I BS EN 1021-2 (allumette) BS EN 1021-1 (cigarette)

Tissu Vita - Tarif Groupe II



V-01 Gris clair



V-02 Beige



V-03 Jaune



V-04 Gris



V-07 Gris foncé



V-09 Olive



V-10 Gris marron



V-11 Rouille



V-12 Noir



V-13 Chocolat



V-18 Aigue marine



V-19 Bleu



V-29 Vert foncé

Données techniques :

Composition	Surface: 98,5% PVC, 1,5% PU Couche Intérieure: 50% polyester, 50% Coton
Poids du tissu	850g/m ² ± 10% (1190G/lin. m ± 10%)
Résistance à l'abrasion	BS EN ISO 5470-2, 100,000 Martindale
Tenue à la lumière	6 (ISO 105 - B02)
Résistance au frottement	humide: 4, sec: 4 (ISO 105 - X12)
Normes au feu	BS EN 1021 - (cigarette) BS EN 1021 - 2 (allumette) BS 5852 - (Ignition Source) BS 7176 - (Medium Hazard)
Résistance à la flexion	BS EN ISO 7854 - Method B, 400.000 Flexing cycles
Traitement anti-microbien / antibactérien	AATCC 147

* Il est possible de commander l'ensemble des références Atlantic de l'offre Gabriel (hors standard .mdd), sous un délai de 8 semaines

Stilt	Date 27.10.2021	Ces données sont valides à la date d'élaboration. Les évolutions des produits, si elles ne touchent pas les caractéristiques fondamentales, n'impliquent pas une mise à jour systématique de la fiche technique.	page 9/13
			coloris

Tissu Charles - Tarif Groupe II



Données techniques :

Composition	100% polyester
Poids du tissu	433g/m ²
Résistance à l'abrasion	90,000 cycles de martindale (EN ISO 12947-2)
Résistance au boulochage	EN ISO 12945-2, 5
Tenue à la lumière	EN ISO 105-B02, 5
Résistance au frottement	sec: 4-5, humide: 4-5, EN ISO 105x12
Normes au feu	EN 1021, 1

Tissu Mica - Tarif Groupe II



Données techniques :

Composition	polyester recyclé post-consommation 97%, polyester 3%
Poids du tissu	305g/lm
Résistance à l'abrasion	60,000 frotte la martindale (EN ISO 12947-2)
Résistance au boulochage	échelle 1-5, max. 5 - EN ISO 12945-2, 4-5
Tenue à la lumière	échelle 1-8, max. 8 - EN ISO 105-B02, 5-8
Résistance au frottement	sec: 4-5, humide: 4-5, échelle 1-5, max. 5 - EN ISO 105x12
Normes au feu	CA TB 117-2013 ASTM E 84 Classe I Cigarette BS EN 1021-1 Correspondance BS EN 1021-2 BS 476 partie 7 classe I

Tissu Go Check - Tarif Groupe II

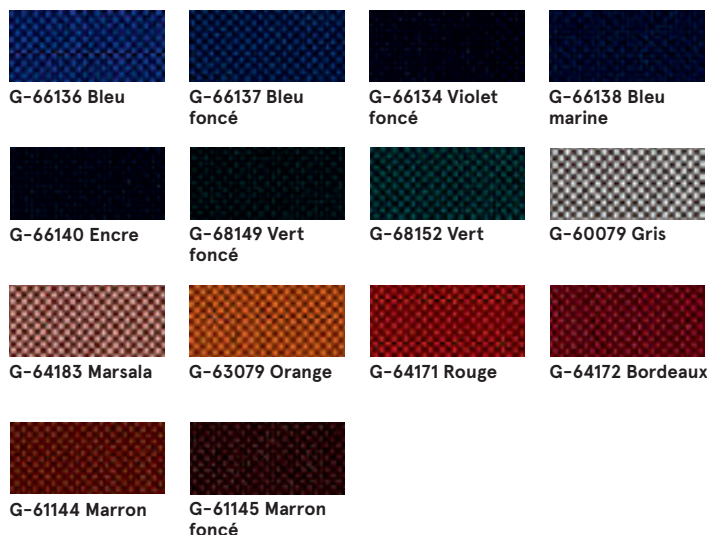

Données techniques :

Composition 100% Trevira CS

Poids du tissu 435g/lm

Résistance à l'abrasion 80,000 frotte la martindale (EN ISO 12947-2)

Résistance au boulochage échelle 1-5, max. 5 - EN ISO 12945-2, 5

Tenue à la lumière échelle 1-8, max. 8 - EN ISO 105-B02, 5-8

Résistance au frottement sec: 4-5, humide: 4-5, échelle 1-5, max. 5 - EN ISO 105x12

Normes au feu BS EN 1021 1 & 2 Cigarette et Match
Cigarette BS EN 1021-1
BS 5852 Berceau 5
BS 7176 Risque moyen
DIN 4102 - B1
NFP 92-503 / 504/505 M1
ÖNORM A3800-B1-B3825-Q1 Royaume-Uni
Classe Uno UNI 9175 Classe 1 I EMME
FAR / JAR 25.853 (a) (i) (ii)
CA TB 117-2013
DIN EN 13501-1 B-s1, d0
AM 18 - NF D 60-013- (uniquement pour tissu)

Tissu Xtreme - Tarif Groupe III



Données techniques :

Composition 100% Trevira Clame (CS)
100% Recycling (YS)
Polyester retardateur de flamme.
Teintures non métalliques.

Poids du tissu 310 g/m2 ±5% (435g/lin.m ±5%)

Résistance à l'abrasion 60,000 Martindale (CS)
100,000 Martindale (YS)

Tenue à la lumière 6 (ISO 105 - B02)

Résistance au frottement Humide: 4, Sec: 4 (ISO 105 - X12)

Normes au feu EN 1021 - 1 (cigarette),
EN 1021 - 2 (allumette)
BS 7176 Low Hazard,
NF P92-507 M1, DIN 4102 B1,
UNI 9175 Klasa 1 IM, UNI 8456,
UNI 9174 & UNI 9177 Classe Uno,
ÖNORM B 3825 & A 3800-1
NF D 60-013

Tissu Synergy - Tarif Groupe III

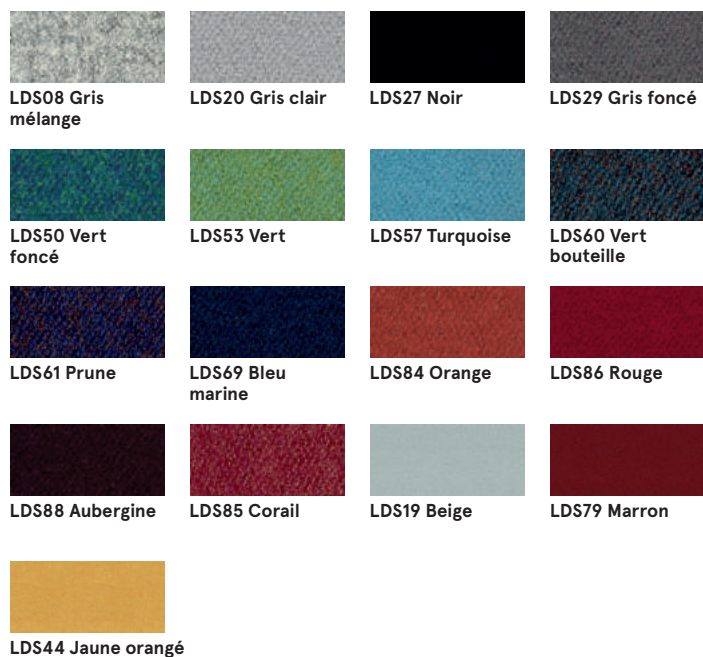

Données techniques :

Composition 95% Laine Vierge, 5% Polyamide

Poids du tissu 400g/m2 ±5% (560 g/lin.m ±5%)

Résistance à l'abrasion Certificat indépendant
≥100,000 Martindale

Tenue à la lumière 5 (ISO 105 - B02)

Résistance au frottement ISO 105 - X12 - humide: 4, sec: 4

Normes au feu EN 1021 - 1 (cigarette),
EN 1021 - 2 (allumette),
BS 7176 Faible danger,
UNI 9175 Classe 1 IM,
ÖNORM B 3825 & A 3800-1

Tissu Silvertex – Tarif Groupe III

Il est possible de commander l'ensemble des références Silvertex de l'offre Spradling, délai standard mdd.

Données techniques :

Composition	couche supérieure : 100% vinylo support : 100% polyester Hi-Loft™
Poids du tissu	685 gr/m2
Résistance à l'abrasion	>300,000 tours Martindale
Résistance UV	>= 7 (1000 heures, DIN 54004 / NTC 1479 - laine bleue)
Temp. extrêmes	-23°C
Réaction au feu	NF P 92-503 / M2 EN 1021, Part 1&2 DIN 4102 B2 ÖNORM B 3825, Gruppe I - Schwerbrennbares Verhalten ÖNORM A 3800, Teil I, Qualmbildungsklasse QI - schwachqualmend IMO Res. MSC.307 (88) (2010 FTP Code) Annex I Part 8 (MED) Marine Equipment Directive in its current valid version UNI 9175 (1987) / UNI 9175/FAI (1994) Classe I.IM (uno I EMME) UNE 23.727-90 IR /M2 EN 71-2: 2006+A1: 2007 Safety of Toys - Part 2: Flammability ECE R 118 (replaces Directive 95/28/EC) FMVSS 302 FAR 25/853
Revêtement protecteur	Protection Antimicrobienne, Protection Anti

Tissu Atlas – Tarif Groupe IV

			
AS-531 Orange	AS-501 Rose	AS-651 Rouge	AS-681 Bordeaux
			
AS-391 Marron	AS-781 Bleu marine	AS-161 Gris foncé	AS-111 Gris clair
			
AS-971 Vert clair	AS-981 Vert foncé		

Données techniques :

Composition	90% laine vierge, 10% nylon
Poids du tissu	286g/m2, 400g/ml
Résistance à l'abrasion	100,000 tours Martindale, EN ISO 12947
Tenue à la lumière	ISO 105 B02: 6-7
Résistance au frottement	ISO 105-X12:2001, (humide/sec) 4-5/4-5
Normes au feu	BS EN 1021-2 Match, BS EN 1021-1 Cigarette, BS 5 5852 Crib 5, BS 5852 ignition source 3, BS 5852 Part 1, NF D 60 013, UNI 9175 1IM, US Cal. Bull. 117-2013

Tissu Field2 – Tarif Groupe IV

			
FD-463 Jaune orangé	FD-963 Vert	FD-123 Beige	FD-132 Gris
			
FD-142 Graphite	FD-662 Rouge	FD-673 Bleu -rouge	FD-782 Bleu marine
			
FD-693 Bordeaux	FD-192 Noire		

Données techniques :

Composition	100% Trevira CS
Poids du tissu	321g/m2, 450g/ml
Résistance à l'abrasion	100,000 tours Martindale, EN ISO 12947
Tenue à la lumière	ISO 105 B02: 5-7
Normes au feu	BS EN 1021-2 Match, BS EN 1021-1 Cigarette, BS 5 5852 Crib 5, DIN 4102 B1 FAR 25.853, UNI 9177 classe 1, US Cal. Bull. 117-2013

Cuir - Tarif Groupe IV



Données techniques :

Matériau	Type de cuir - cuir fleur corrigée
	Type de finition - cuir pigmenté
Résistance des couleurs au frottement	Sec : 500 cycles - min. indice 4 échelle de gris
	Humide : 250 cycles - min. indice 4 échelle de gris
	UNI EN ISO 11640
Résistance des couleurs à la lumière	min. indice 4 échelle de gris
	UNI ISO 105-802
Réaction au feu	non inflammable selon norme
	UNI EN 1021-1-2006
	BS EN 1021-1-2006

Base - métal



Rangements ouverts - dessus et top

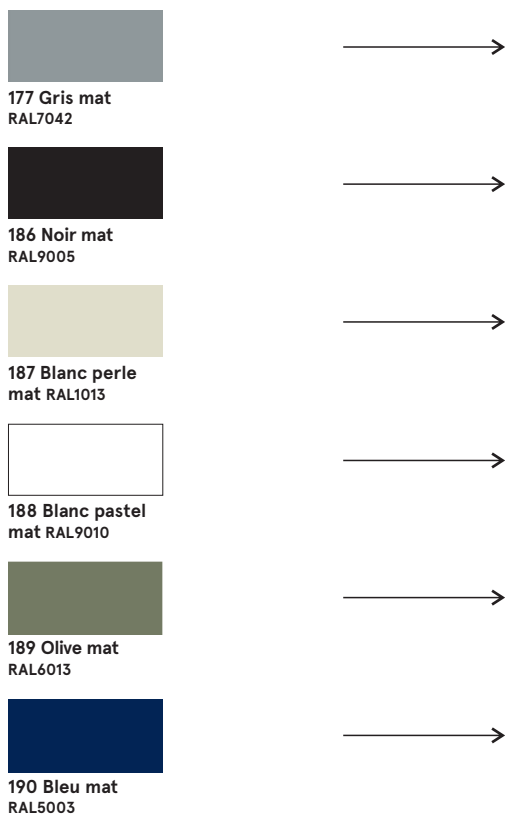

Structure

