

# Ogi Q

## descriptif technique



.mdd

MDD, créée en 1993 à Sępólno Krajeńskie en Pologne, est d'abord une histoire d'amitié entre Jaroslaw DABROWSKI et Zbigniew MATTYA.

Depuis l'origine, nous souhaitons incarner un modèle d'entreprise où l'humain est la première des préoccupations. Nous considérons que l'épanouissement personnel de chaque membre de notre équipe, est la clé de notre succès. Garder comme piliers des valeurs familiales participe à ce projet.

Nous créons du mobilier répondant aux besoins spécifiques des espaces de travail. Pour vous permettre de favoriser le travail collaboratif, la créativité et les échanges dans l'entreprise, nous vous proposons un mobilier design, conçu PAR et POUR l'homme. Grâce à notre politique de réinvestissement constant dans l'outil de production nous disposons d'un parc de machines modernes, permettant une fabrication de qualité. Citoyens du monde, nous agissons aujourd'hui en pensant aux générations de demain. Ainsi nous utilisons des matériaux au taux de recyclabilité proche de 95%.

Le monde du travail est en mutation constante. Nous veillons, et collaborons avec des designers et nos clients, pour anticiper et être toujours au plus près du besoin.



## Informations générales :

### Garantie :

Produits MDD - **5 ans**.

Composants électriques et tissus - **2 ans**.

### Méla miné - certifié :



### Montage :

livrée en pièces détachées

### Emballage :

carton, enveloppe en plastique perforé

### Conforme aux normes :

PN-EN 527-2:2017-02

### Densité du panneau :

12 mm - 690 - 750 kg/m<sup>3</sup>

18 mm - 650 - 690 kg/m<sup>3</sup>

28 mm - 610 - 630 kg/m<sup>3</sup>

36 mm - 610 - 630 kg/m<sup>3</sup>

Plateaux bureaux Ogi

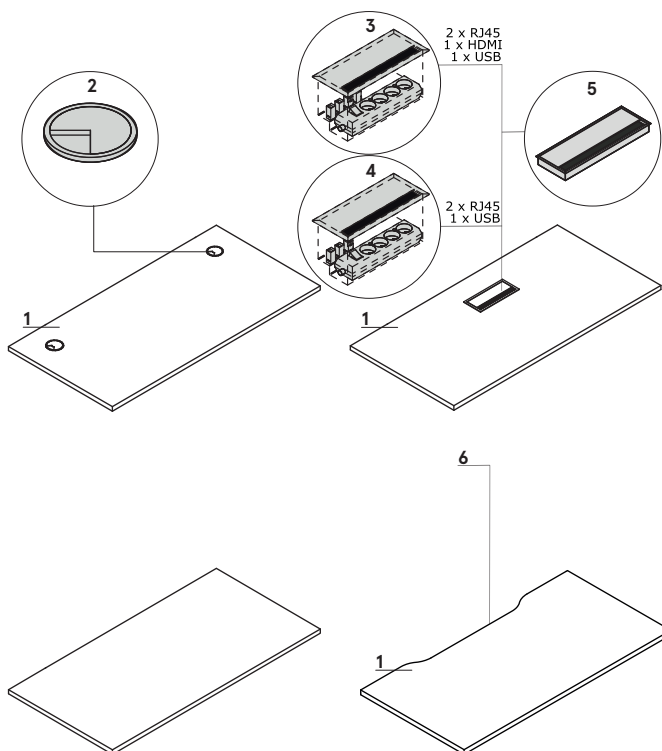

1. Plateau - mélaminé 28 mm, chants ABS

OPTION PAYANTE:

2. Obturateurs - 2 pcs, Ø 80 mm

3. Mediabox M04H - 2xRJ45 (classe E, cat. 6); 1xUSB/1xHDMI/4x230V, couleur: M009 - aluminium semi-mate

4. Mediabox M04 - 2xRJ45 (classe E, cat. 6); + 1 x USB + 4 x 230V, couleur: M009 - aluminium semi-mate

5. Top access M05 - couleur: M009 - aluminium semi-mate

6. Passage de câbles - la largeur de l'ouverture est proportionnelle à la largeur du plan de travail

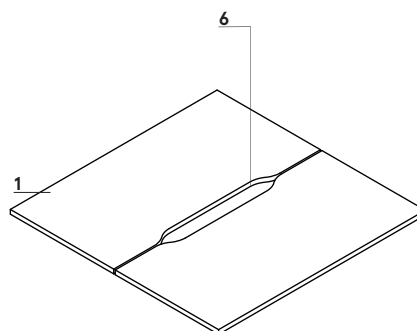

Dimensions du plateau avec découpe pour passage de câbles (mm)

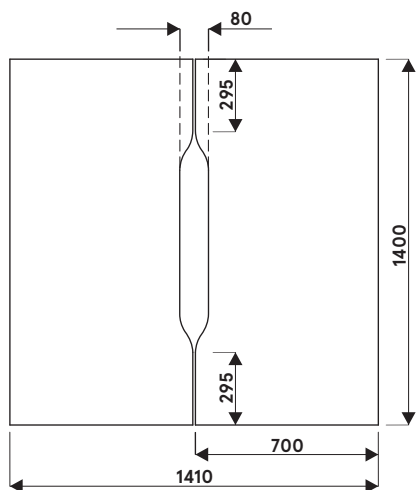

Ogi Q	Date 18.11.2019	Ces données sont valides à la date d'élaboration. Les évolutions des produits, si elles ne touchent pas les caractéristiques fondamentales, n'impliquent pas une mise à jour systématique de la fiche technique.	page 3/9 descriptif et composition
-------	--------------------	---	---------------------------------------

Piétement

Ogi Q: métal finition peinture poudre époxy, profil 60x20 mm, entretoise 10 mm

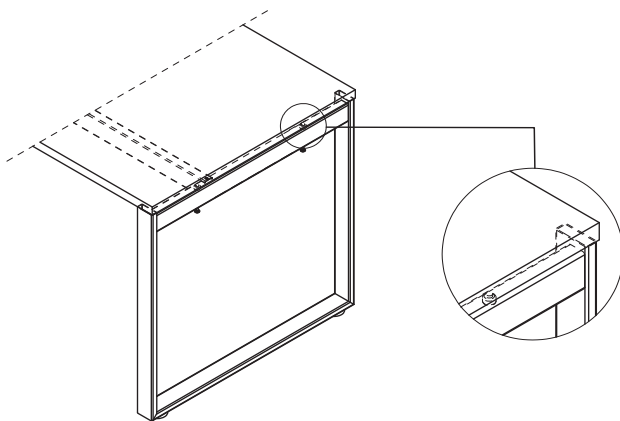

Bureaux manager sur meuble retour porteur

- 1. Plateau - mélaminé 28 mm, chants ABS
- 2. Top - mélaminé 28 mm, chants ABS
- 3. Tablette - mélaminé 18 mm, protection contre les chutes accidentelles, chants ABS
- 4. Tiroir - mélaminé 18 mm; chants ABS, serrure, possibilité de le changer de place
- 5. Base - mélaminé 18 mm, chants ABS
- 6. Façade - mélaminé 18 mm, chants ABS

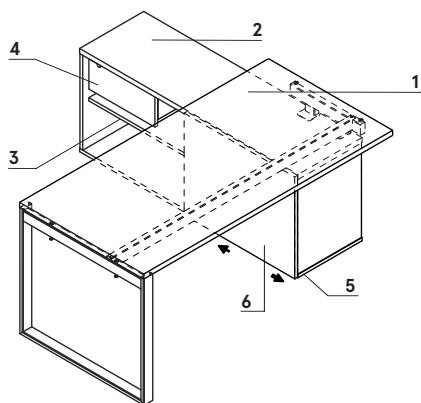

www.mdd.eu

Exemples de configurations (mm)

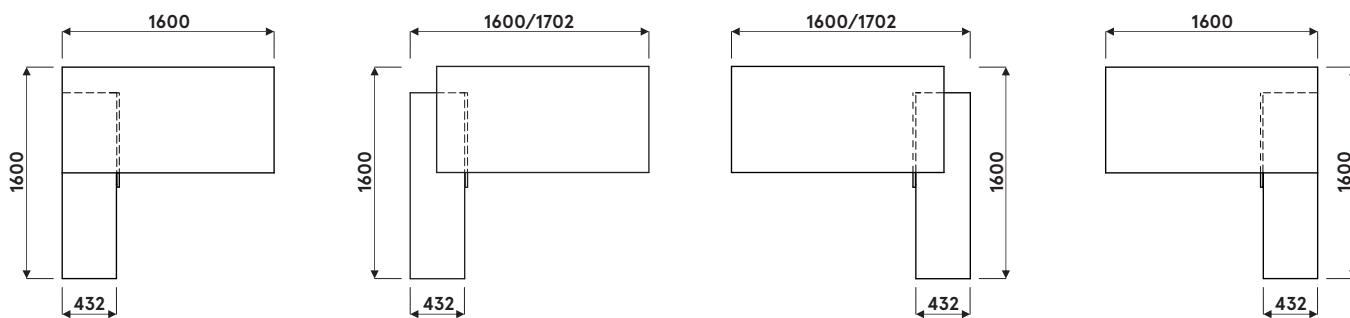

Exemples de configurations (mm)

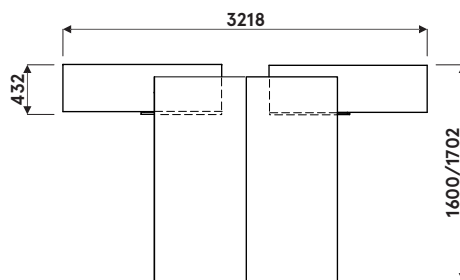
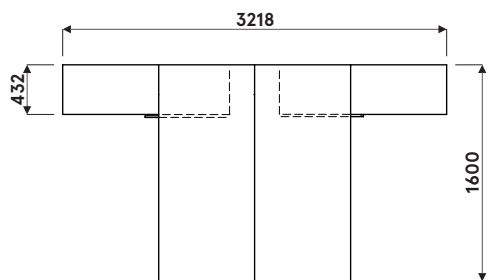

Exemples de configuration avec BOX40, BOX50, BOX60

www.mdd.eu

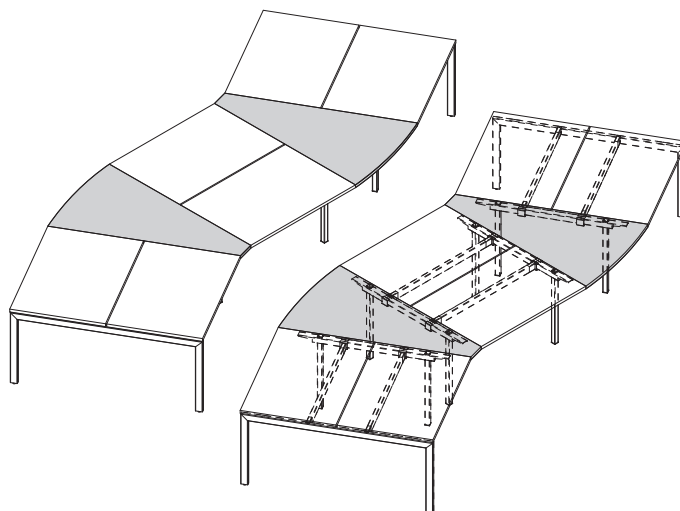
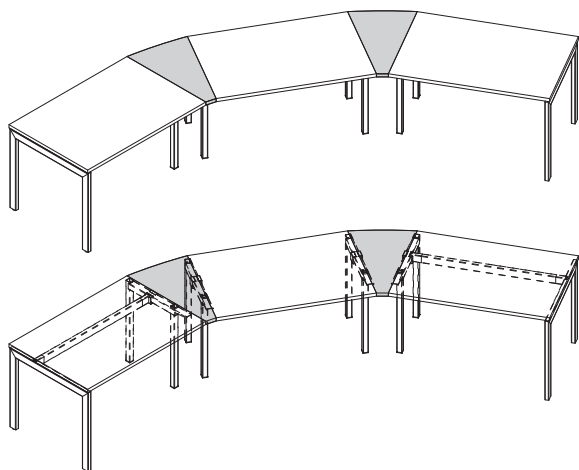

REMARQUE - Uniquement pour les systèmes Ogi Q, Ogi U, Ogi Y, Ogi W, Ogi M

Accessoires

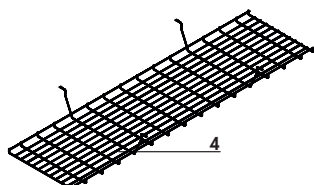
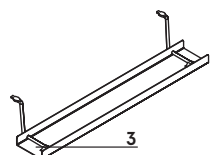
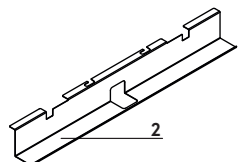
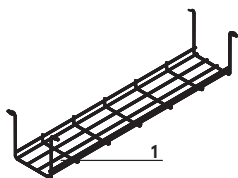

1. **Chemin de câbles S69** - métal finition peinture poudre époxy, couleur 09 - aluminium
2. **Chemin de câbles (SG12, SG16)** - pour bureau individuel, métal finition peinture poudre époxy, couleur M009 - aluminium semi-mate
3. **Chemin de câbles E64** - métal finition peinture poudre époxy, couleur M009 - aluminium semi-mate
4. **Chemin de câbles pour bench Ogi (SG220, SG260)** - fil acier Ø4 mm, métal finition peinture poudre époxy, couleur : 09 - aluminium

Ogi Q	Date 18.11.2019	Ces données sont valides à la date d'élaboration. Les évolutions des produits, si elles ne touchent pas les caractéristiques fondamentales, n'impliquent pas une mise à jour systématique de la fiche technique.	page 5/9 descriptif et composition
-------	--------------------	---	---------------------------------------

Bureaux droits

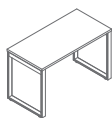

**BOQ12**  
1200 / 600 / 740  
31.9 kg

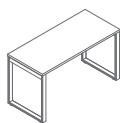

**BOQ14**  
1400 / 600 / 740  
35 kg

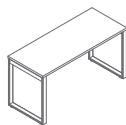

**BOQ16**  
1600 / 600 / 740  
38.1 kg

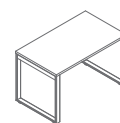

**BOQ22**  
1200 / 700 / 740  
35.5 kg

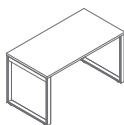

**BOQ24**  
1400 / 700 / 740  
38.9 kg

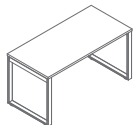

**BOQ26**  
1600 / 700 / 740  
42.5 kg

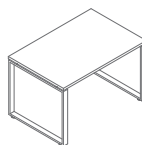

**BOQ02**  
1200 / 800 / 740  
41 kg

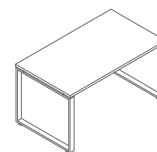

**BOQ03**  
1400 / 800 / 740  
41.5 kg

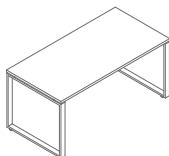

**BOQ04**  
1600 / 800 / 740  
42.1 kg

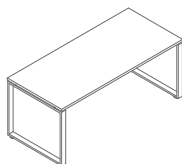

**BOQ05**  
1800 / 800 / 740  
45.2 kg

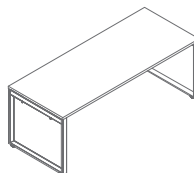

**BOQ06**  
2000 / 800 / 740  
51.5 kg

www.mdd.eu

Élément suivant - pour bureau droit



**BOX40**  
500 / 800 / 740  
10.8 kg

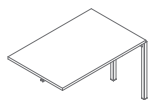

**BOX42**  
1200 / 800 / 740  
31.6 kg

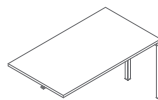

**BOX43**  
1400 / 800 / 740  
32.1 kg

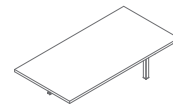

**BOX44**  
1600 / 800 / 740  
32.7 kg

Élément suivant - pour bureau droit

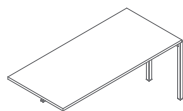

**BOX45**  
1600 / 800 / 740  
35.8 kg

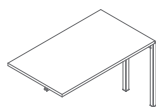

**BOX32**  
1200 / 700 / 740  
26.3 kg

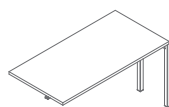

**BOX34**  
1400 / 700 / 740  
29.7 kg

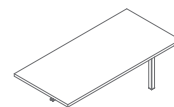

**BOX36**  
1600 / 700 / 740  
33.3 kg

Benchs

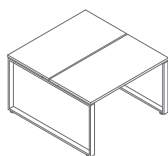

**BOQ42**  
1200 / 1410 / 740  
51.9 kg

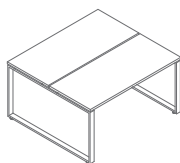

**BOQ44**  
1400 / 1410 / 740  
58.7 kg

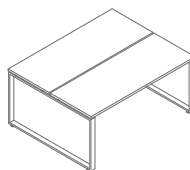

**BOQ46**  
1600 / 1410 / 740  
65.9 kg

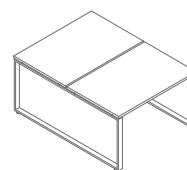

**BOQ32**  
1200 / 1610 / 740  
61 kg

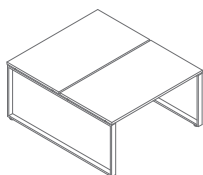

**BOQ33**  
1400 / 1610 / 740  
62.6 kg

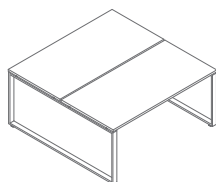

**BOQ34**  
1600 / 1610 / 740  
63.8 kg

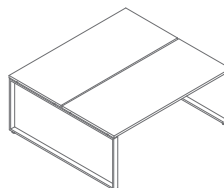

**BOQ35**  
1800 / 1610 / 740  
70 kg

Élément de jonction et élément suivant - pour bench

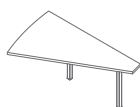

**BOX50**  
1000 / 1410 / 740  
16.5 kg

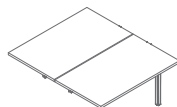

**BOX52**  
1200 / 1410 / 740  
49.4 kg

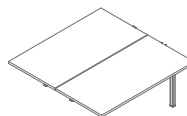

**BOX54**  
1400 / 1410 / 740  
56.2 kg

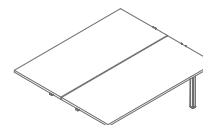

**BOX56**  
1600 / 1410 / 740  
63.4 kg

Élément de jonction et élément suivant - pour bench

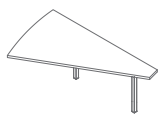

**BOX60**  
1000 / 1610 / 740  
17,5 kg

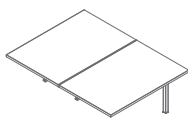

**BOX62**  
1200 / 1610 / 740  
60,1 kg

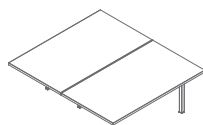

**BOX64**  
1400 / 1610 / 740  
61,1 kg

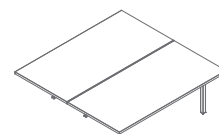

**BOX66**  
1600 / 1610 / 740  
62,3 kg

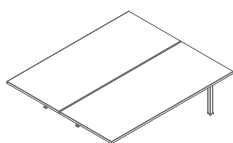

**BOX68**  
1800 / 1610 / 740  
68,5 kg

Bureaux sur meuble retour porteur

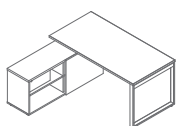

**BOQL20**  
1600-1702 / 1600 / 740  
94,4 kg

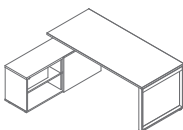

**BOQL21**  
1800-1902 / 1600 / 740  
97,5 kg

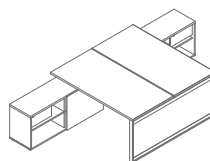

**BOQL40**  
1600-1702 / 3210 / 740  
185,8 kg

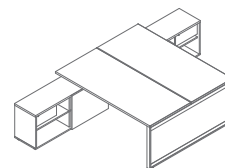

**BOQL41**  
1800-1902 / 3210 / 740  
192 kg

Retours / extensions

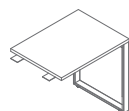

**PLQ01**  
600 / 800 / 740  
19,5 kg

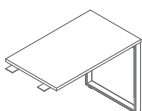

**PLQ02**  
600 / 1000 / 740  
20,7 kg

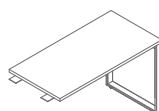

**PLQ03**  
600 / 1200 / 740  
23,2 kg



Plateau, top, base, corps, façade



Passes câbles

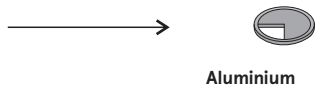

Aluminium

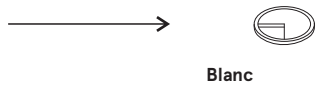

Blanc

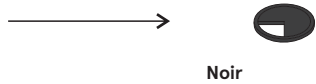

Noir

Piétement - métal

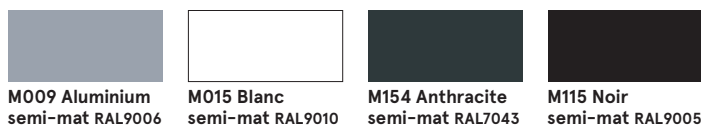

\* corps - groupe II