

Bazalto descriptif technique



.mdd

.mdd, créée en 1993 à Sępólno Krajeńskie en Pologne, est d'abord une histoire d'amitié entre Jaroslaw DABROWSKI et Zbigniew MATTYA.

Depuis l'origine, nous souhaitons incarner un modèle d'entreprise où l'humain est la première des préoccupations. Nous considérons que l'épanouissement personnel de chaque membre de notre équipe, est la clé de notre succès. Garder comme piliers des valeurs familiales participe à ce projet.

Nous créons du mobilier répondant aux besoins spécifiques des espaces de travail. Pour vous permettre de favoriser le travail collaboratif, la créativité et les échanges dans l'entreprise, nous vous proposons un mobilier design, conçu PAR et POUR l'homme. Grâce à notre politique de réinvestissement constant dans l'outil de production nous disposons d'un parc de machines modernes, permettant une fabrication de qualité. Citoyens du monde, nous agissons aujourd'hui en pensant aux générations de demain. Ainsi nous utilisons des matériaux au taux de recyclabilité proche de 95%.

Le monde du travail est en mutation constante. Nous veillons, et collaborons avec des designers et nos clients, pour anticiper et être toujours au plus près du besoin.



Informations générales :

Garantie :

Produits .mdd - **5 ans.**

Composants électriques et tissus - **2 ans.**

Mélangé - certifié :



Tissus - certifié :



Montage :

livrée en pièces détachées

Emballage :

film mousse

Bazalto	Date 17.05.2022	Ces données sont valides à la date d'élaboration. Les évolutions des produits, si elles ne touchent pas les caractéristiques fondamentales, n'impliquent pas une mise à jour systématique de la fiche technique.	page 2/12
			informations générales

Descriptif technique - Bazalto

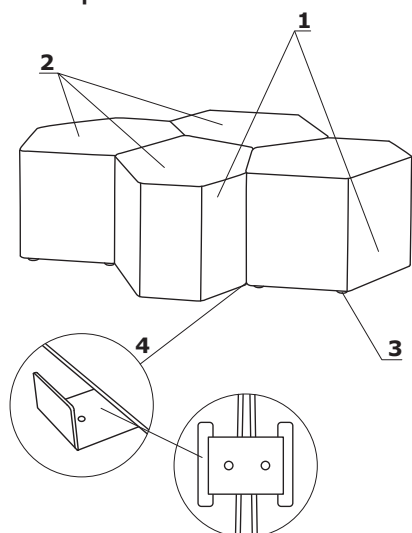

1. **Corps** - panneaux de 18 et 28 mm et HDF 3 mm, monté avec vis d'assemblage confirmats
2. **Assise** - mousse découpée: épaisseur 50 mm
3. **Patins en polypropylène** - Ø30 mm; 6 pcs
4. **Éléments de jonction en métal** - profil 2 mm découpé au laser, peinture poudre époxy noire

- charge max 120 kg

Descriptif technique - table basse

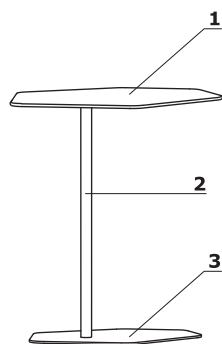

1. **Top** - stratifié compact HPL, ép. 10 mm
2. **Piètement** - colonne tube métallique Ø 30 mm, ép. 2 mm, finition peinture poudre époxy
3. **Base** - métal finition peinture poudre époxy

Exemples de configurations

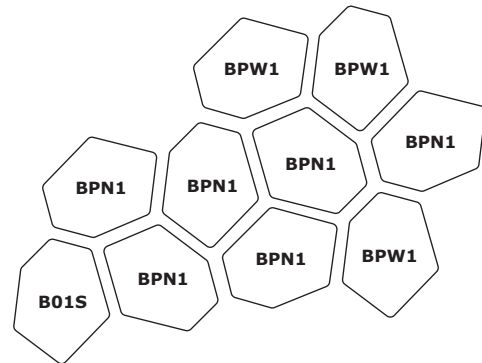
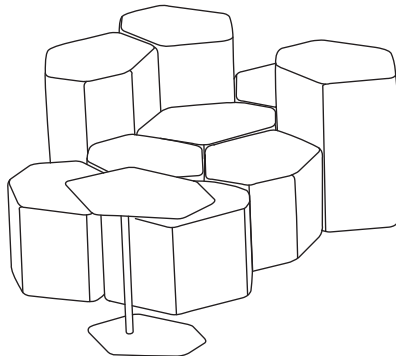
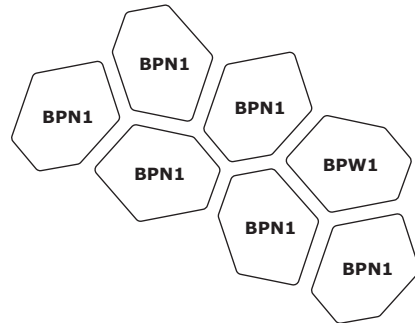
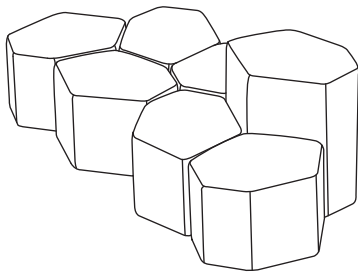
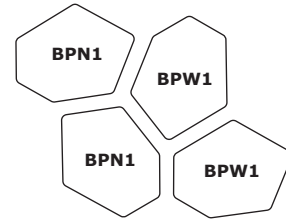
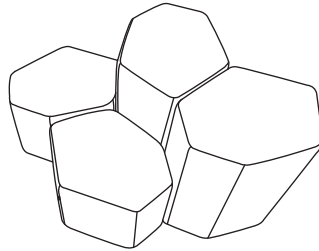
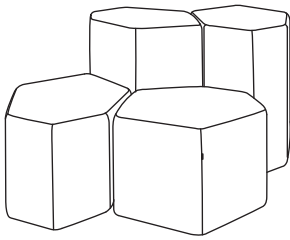
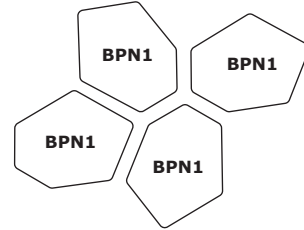
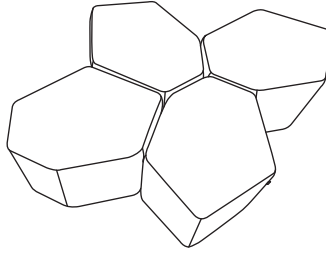
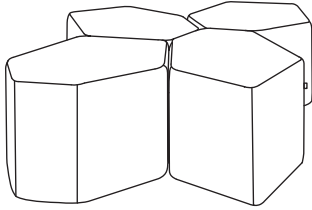
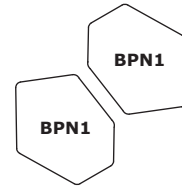
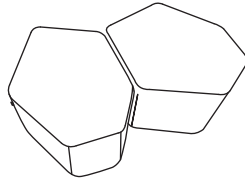
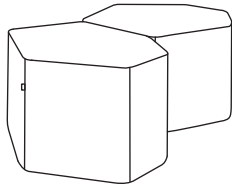

Dimensions - Bazalto

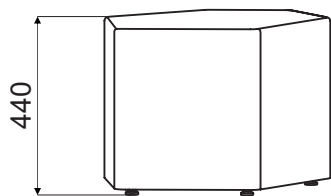

BPN1

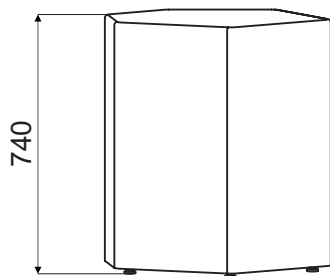

BPN2

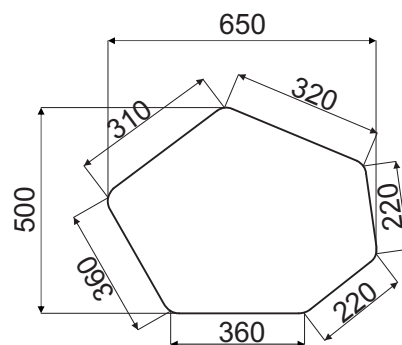

Dimensions - table base

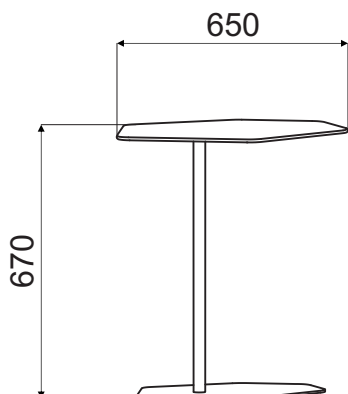

B01S

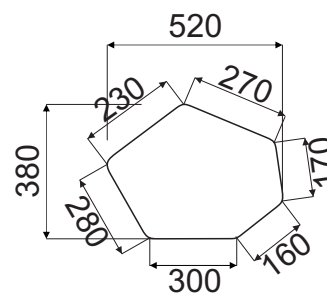
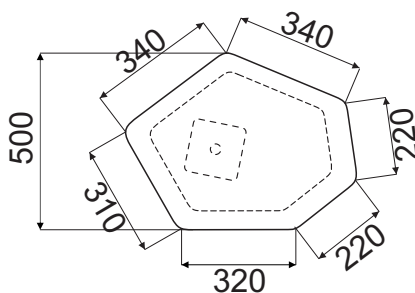

Bazalto *



BPN1
650 / 500 / 440
10.1 kg

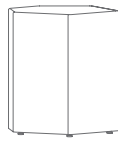

BPW1
650 / 500 / 740
12.9 kg

Table basse *



B01S
650 / 500 / 670
8 kg

* Dimensions exprimées en millimètre : Largeur x Profondeur x Hauteur

Bazalto	Date 17.05.2022	Ces données sont valides à la date d'élaboration. Les évolutions des produits, si elles ne touchent pas les caractéristiques fondamentales, n'impliquent pas une mise à jour systématique de la fiche technique.	page 6/12
			synoptique

Tissu Nemo

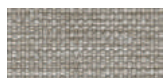

NE-1 Beige



NE-2 Jaune orangé

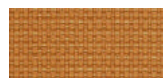

NE-3 Orange



NE-5 Rouge



NE-9 Vert



NE-10 Gris

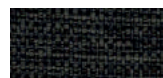

NE-14 Graphite



NE-15 Bleu marine



NE-16 Noir



NE-17 Bleu

Données techniques :

Composition	polyester 100%
Poids du tissu	366g/m ²
Résistance à l'abrasion	PN_EN ISO 12947 - 2:2 100,000
Résistance au boulochage	scale 1-8, max. 8, PN-EN ISO 105 - B02 (3-4)
Tenue à la lumière	scale 1-5, max. 5, PN-EN 1021 - 2,
Résistance au frottement	PN-EN 1021 - 1 skcale 1-5, max. 5, EN ISO 105x12 (humide/sec) 4-5

Tissu Medley - Tarif Groupe II

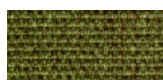

M-68005 Olive foncée

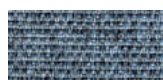

M-66008 Gris



M-64019 Rouge



M-63064 Rose



M-60999 Noir

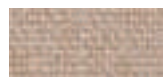

M-61189 Beige



M-60003 Gris clair



M-62054 Moutarde



M-62002 Jaune



M-66010 Bleu



M-65011 Gris-violet



M-63017 Rouille



M-67006 Bleu clair

Données techniques :

Composition	polyester 100%
Poids du tissu	510 g/lm (16.45 oz/lin.yd.)
Résistance à l'abrasion	BS EN ISO 12947-2, 75,000 Martindale
Résistance au boulochage	scale 1-5, max. 5, EN ISO 12945-2 (4)
Tenue à la lumière	scale 1-8, max. 8, EN ISO 105-B02 (5-7)
Résistance au frottement	scale 1-5, max. 5, EN ISO 105x12 (humide/sec) (4-5/4-5)
Absorption acoustique	ISO 354
Normes au feu	BS EN 1021-1 (cigarette) BS 476 Class 2 Class Uno UNI 9174 - UNI 8457 CA TB 117-2013 ASTM E 84 Class I

Tissu Atlantic * - Tarif Groupe II



A-67043 Bleu vert foncé



A-67030 Aigue marine



A-60141 Gris clair

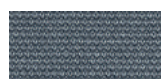

A-60011 Gris



A-66064 Bleu marine



A-65037 Violet



A-62048 Olive



A-64089 Rouge



A-61078 Beige



A-60025 Graphite

Données techniques :

Composition	polyester 100%
Poids du tissu	530 g/lm (17.09 oz/lin.yd.)
Résistance à l'abrasion	BS EN ISO 12947-2, 110,000 Martindale
Résistance au boulochage	scale 1-5, max. 5, EN ISO 12945-2 (4-5)
Tenue à la lumière	scale 1-8, max. 8, EN ISO 105-B02 (5-7)
Résistance au frottement	scale 1-5, max. 5, EN ISO 105x12 (humide/sec) (4-5/4-5)
Normes au feu	CA TB 117-2013 ASTM E 84 Class I BS EN 1021-2 (allumette) BS EN 1021-1 (cigarette)

* Il est possible de commander l'ensemble des références Atlantic de l'offre Gabriel (hors standard MDD), sous un délai de 8 semaines

Tissu Vita - Tarif Groupe II



Données techniques :

Composition	Surface: 98,5% PVC, 1,5% PU Couche Intérieure: 50% polyester, 50% Coton
Poids du tissu	850g/m ² ± 10% (1190G/lin. m ± 10%)
Résistance à l'abrasion	BS EN ISO 5470-2, 100,000 Martindale
Tenue à la lumière	6 (ISO 105 - B02)
Résistance au frottement	humide: 4, sec: 4 (ISO 105 - X12)
Normes au feu	BS EN 1021 - (cigarette) BS EN 1021 - 2 (allumette) BS 5852 - (Ignition Source) BS 7176 - (Medium Hazard) BS EN ISO 7854 - Method B, 400.000 Flexing cycles
Résistance à la flexion	AATCC 147
Traitement anti-microbien / antibactérien	

Tissu Charles * - Tarif Groupe II



Données techniques :

Composition	100% polyester
Poids du tissu	433g/m ²
Résistance à l'abrasion	90,000 cycles de martindale (EN ISO 12947-2)
Résistance au boulochage	EN ISO 12945-2, 5
Tenue à la lumière	EN ISO 105-B02, 5
Résistance au frottement	sec: 4-5, humide: 4-5, EN ISO 105x12
Normes au feu	EN 1021, 1

* Il est possible de commander l'ensemble des références Charles de l'offre Dekoma (hors standard .mdd), en délai de livraison standard

Tissu Mica - Tarif Groupe II



Données techniques :

Composition	polyester recyclé post-consommation 97%, polyester 3%
Poids du tissu	305g/lm
Résistance à l'abrasion	60,000 frotte la martindale (EN ISO 12947-2)
Résistance au boulochage	échelle 1-5, max. 5 - EN ISO 12945-2, 4-5
Tenue à la lumière	échelle 1-8, max. 8 - EN ISO 105-B02, 5-8
Résistance au frottement	sec: 4-5, humide: 4-5, échelle 1-5, max. 5 - EN ISO 105x12
Normes au feu	CA TB 117-2013 ASTM E 84 Classe I Cigarette BS EN 1021-1 Correspondance BS EN 1021-2 BS 476 partie 7 classe I

Tissu Go Check - Tarif Groupe II

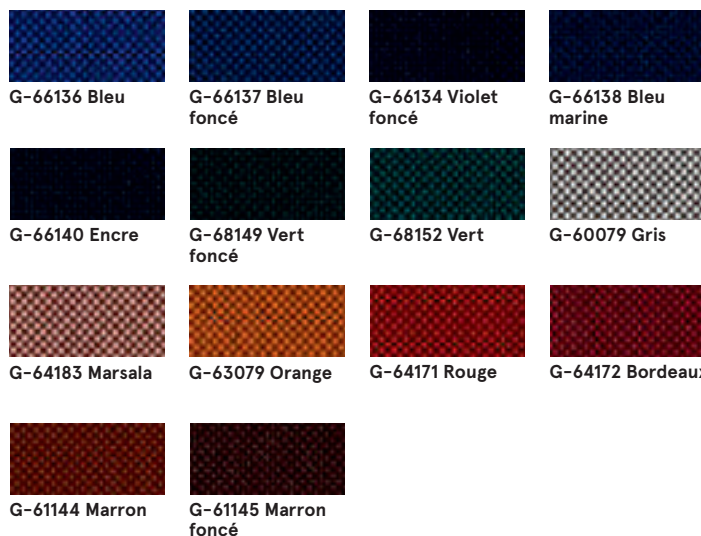

Données techniques :

Composition	100% Trevira CS
Poids du tissu	435g/lm
Résistance à l'abrasion	80,000 frotte la martindale (EN ISO 12947-2)
Résistance au boulochage	échelle 1-5, max. 5 - EN ISO 12945-2, 5
Tenue à la lumière	échelle 1-8, max. 8 - EN ISO 105-B02, 5-8
Résistance au frottement	sec: 4-5, humide: 4-5, échelle 1-5, max. 5 - EN ISO 105x12
Normes au feu	BS EN 1021 1 & 2 Cigarette et Match Cigarette BS EN 1021-1 BS 5852 Berceau 5 BS 7176 Risque moyen DIN 4102 - B1 NFP 92-503 / 504/505 M1 ÖNORM A3800-B1-B3825-Q1 Royaume-Uni Classe Uno UNI 9175 Classe 1 EMME FAR / JAR 25.853 (a) (i) (ii) CA TB 117-2013 DIN EN 13501-1 B-s1, d0 AM 18 - NF D 60-013- (uniquement pour tissu)

Tissu Xtreme - Tarif Groupe III



Données techniques :

Composition 100% Trevira Clame (CS)
100% Recykring (YS)
Polyester retardateur de flamme.
Teintures non métalliques.

Poids du tissu 310 g/m² ±5% (435g/lin.m ±5%)

Résistance à l'abrasion 60,000 Martindale (CS)
100,000 Martindale (YS)

Tenue à la lumière 6 (ISO 105 - B02)

Résistance au frottement Humide: 4, Sec: 4 (ISO 105 - X12)

Normes au feu EN 1021 - 1 (cigarette),
EN 1021 - 2 (allumette)
BS 7176 Low Hazard,
NF P92-507 M1, DIN 4102 B1,
UNI 9175 Klasa 1 IM, UNI 8456,
UNI 9174 & UNI 9177 Classe Uno,
ÖNORM B 3825 & A 3800-1
NF D 60-013

Tissu Synergy - Tafir Groupe III

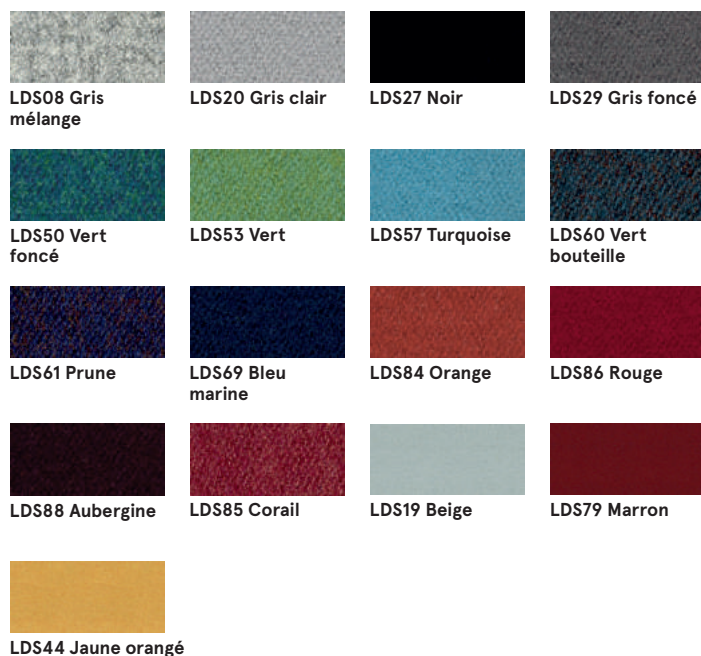

Données techniques :

Composition 95% Laine Vierge, 5% Polyamide

Poids du tissu 400g/m² ±5% (560 g/lin.m ±5%)

Résistance à l'abrasion Certificat indépendant
≥100,000 Martindale

Tenue à la lumière 5 (ISO 105 - B02)

Résistance au frottement ISO 105 - X12 - humide: 4, sec: 4

Normes au feu EN 1021 - 1 (cigarette),
EN 1021 - 2 (allumette),
BS 7176 Faible danger,
UNI 9175 Classe 1 IM,
ÖNORM B 3825 & A 3800-1

Tissu Silvertex – Tarif Groupe III

Il est possible de commander l'ensemble des références Silvertex de l'offre Spradling, délai standard mdd.

Données techniques :

Composition	couche supérieure : 100% vinyloéupport : 100% polyester Hi-Loft™
Poids du tissu	685 gr/m2
Résistance à l'abrasion	>300,000 tours Martindale
Résistance UV	>= 7 (1000 heures, DIN 54004 / NTC 1479 - laine bleue)
Temp. extrêmes	-23°C
Réaction au feu	NF P 92-503 / M2 EN 1021, Part 1&2 DIN 4102 B2 ÖNORM B 3825, Gruppe I - Schwerbrennbares Verhalten ÖNORM A 3800, Teil I, Qualmbildungsklasse QI - schwachqualmend IMO Res. MSC.307 (88) (2010 FTP Code) Annex I Part 8 (MED) Marine Equipment Directive in its current valid version UNI 9175 (1987) / UNI 9175/FAI (1994) Classe I.IM (uno I EMME) UNE 23.727-90 IR /M2 EN 71-2: 2006+A1: 2007 Safety of Toys - Part 2: Flammability ECE R 118 (replaces Directive 95/28/EC) FMVSS 302 FAR 25/853
Revêtement protecteur	Protection Antimicrobienne, Protection Anti

Tissu Atlas – Tarif Groupe IV

			
AS-531 Orange	AS-501 Rose	AS-651 Rouge	AS-681 Bordeaux
			
AS-391 Marron	AS-781 Bleu marine	AS-161 Gris foncé	AS-111 Gris clair
			
AS-971 Vert clair	AS-981 Vert foncé		

Données techniques :

Composition	90% laine vierge, 10% nylon
Poids du tissu	286g/m2, 400g/ml
Résistance à l'abrasion	100,000 tours Martindale, EN ISO 12947
Tenue à la lumière	ISO 105 B02: 6-7
Résistance au frottement	ISO 105-X12:2001, (humide/sec) 4-5/4-5
Normes au feu	BS EN 1021-2 Match, BS EN 1021-1 Cigarette, BS 5 5852 Crib 5, BS 5852 ignition source 3, BS 5852 Part 1, NF D 60 013, UNI 9175 1IM, US Cal. Bull. 117-2013

Tissu Field2 – Tarif Groupe IV

			
FD-463 Jaune orangé	FD-963 Vert	FD-123 Beige	FD-132 Gris
			
FD-142 Graphite	FD-662 Rouge	FD-673 Bleu -rouge	FD-782 Bleu marine
			
FD-693 Bordeaux	FD-192 Noire		

Données techniques :

Composition	100% Trevira CS
Poids du tissu	321g/m2, 450g/ml
Résistance à l'abrasion	100,000 tours Martindale, EN ISO 12947
Tenue à la lumière	ISO 105 B02: 5-7
Normes au feu	BS EN 1021-2 Match, BS EN 1021-1 Cigarette, BS 5 5852 Crib 5, DIN 4102 B1 FAR 25.853, UNI 9177 classe 1, US Cal. Bull. 117-2013

Cuir - Tarif Groupe IV



L01 Noir



L02 Vert foncé



L03 Bleu marine



L04 Marron clair



L05 Marron foncé



L06 Gris

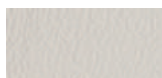

L07 Beige

Données techniques :

Matériau Type de cuir - cuir fleur corrigée

Type de finition - cuir pigmenté

Résistance des couleurs au frottement

Sec : 500 cycles - min. indice 4 échelle de gris

Humide : 250 cycles - min. indice 4 échelle de gris

UNI EN ISO 11640

Résistance des couleurs à la lumière

min. indice 4 échelle de gris

UNI ISO 105-802

Réaction au feu

non inflammable selon norme

UNI EN 1021-1-2006

BS EN 1021-1-2006

Plateau B01S - HPL



30 Blanc



08 Noir

Base B01S - métal

M015 Blanc
semi-mat RAL9010M115 Noir
semi-mat RAL9005