

# Armoires et rangements – Standard descriptif technique



.mdd

MDD, créée en 1993 à Sępólno Krajeńskie en Pologne, est d'abord une histoire d'amitié entre Jaroslaw DABROWSKI et Zbigniew MATTYA.

Depuis l'origine, nous souhaitons incarner un modèle d'entreprise où l'humain est la première des préoccupations. Nous considérons que l'épanouissement personnel de chaque membre de notre équipe, est la clé de notre succès. Garder comme piliers des valeurs familiales participe à ce projet.

Nous créons du mobilier répondant aux besoins spécifiques des espaces de travail. Pour vous permettre de favoriser le travail collaboratif, la créativité et les échanges dans l'entreprise, nous vous proposons un mobilier design, conçu PAR et POUR l'homme. Grâce à notre politique de réinvestissement constant dans l'outil de production nous disposons d'un parc de machines modernes, permettant une fabrication de qualité. Citoyens du monde, nous agissons aujourd'hui en pensant aux générations de demain. Ainsi nous utilisons des matériaux au taux de recyclabilité proche de 95%.

Le monde du travail est en mutation constante. Nous veillons, et collaborons avec des designers et nos clients, pour anticiper et être toujours au plus près du besoin.



## Informations générales :

### Garantie :

Produits MDD - **5 ans**.

Composants électriques et tissus - **2 ans**.

### Mélaminé - certifié :



### Conforme aux normes :

PN-EN 14073-2:2006

### Densité du panneau :

12 mm - 690 - 750 kg/m<sup>3</sup>

18 mm - 650 - 690 kg/m<sup>3</sup>

28 mm - 610 - 630 kg/m<sup>3</sup>

36 mm - 610 - 630 kg/m<sup>3</sup>

### Montage :

livrée en pièces détachées

### Emballage :

carton, film bulle, film étirable

## Armoires et rangements

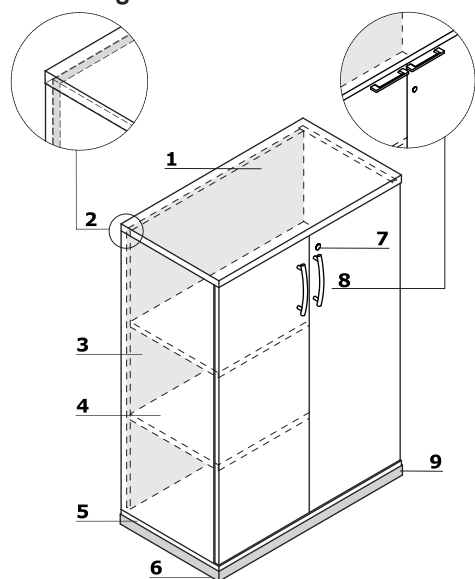

1. **Top** - mélaminé 28 mm, chants ABS
2. **Dos** - mélaminé 18 mm, chants ABS
3. **Corps** - mélaminé 18 mm, chants ABS
4. **Tablette** - mélaminé 18 mm, protection contre les chutes accidentelles, chants ABS
5. **Base** - mélaminé 18 mm, chants ABS
6. **Vérins de réglage 27 mm** - mise à niveau depuis l'intérieur du meuble, course de 5 mm
7. **OPTION AVEC PLUS VALUE** - serrure espagnolette - deux points
8. **Façade** - mélaminé 18 mm, chants ABS, charnières standards 110°
  - Standard - poignée verticale en aluminium
  - Pro (OPTION AVEC PLUS VALUE) - poignée horizontale en aluminium, serrure espagnolette - deux points
9. **OPTION AVEC PLUS VALUE** - plinthe en métal, couleur: M009 - aluminium semi-mate

Rangements

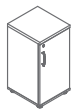

**A26P2**  
402 / 432 / 777  
22 kg

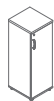

**A36P2**  
402 / 432 / 1129  
30 kg



**A56P2**  
402 / 432 / 1833  
46 kg



**A21B4**  
801 / 432 / 740  
35.5 kg



**A2104**  
801 / 432 / 777  
37 kg

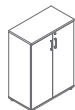

**A3104**  
801 / 432 / 1129  
46.3 kg

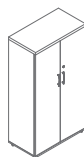

**A4104**  
801 / 432 / 1481  
62 kg



**A5104**  
801 / 432 / 1833  
78.6 kg



**A6104**  
801 / 432 / 2185  
90 kg



**A5NP4**  
802 / 802 / 1833  
107 kg

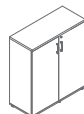

**A3105**  
1000 / 432 / 1129  
64 kg

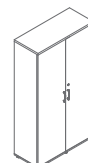

**A5105**  
1000 / 432 / 1833  
98 kg

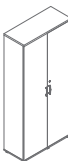

**A6105**  
1000 / 432 / 2185  
141 kg

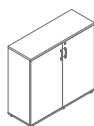

**A3106**  
1200 / 432 / 1129  
73 kg

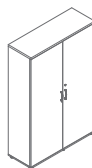

**A5106**  
1200 / 432 / 1833  
111 kg

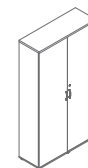

**A6106**  
1200 / 432 / 2185  
131 kg

Rangements ouverts



**A2902**  
402 / 432 / 777  
19 kg



**A3902**  
402 / 432 / 1129  
25 kg



**A5902**  
402 / 432 / 1833  
39 kg



**A25B4**  
801 / 432 / 740  
29 kg

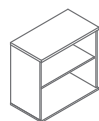

**A2504**  
801 / 432 / 777  
30 kg

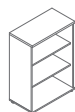

**A3504**  
801 / 432 / 1129  
35 kg

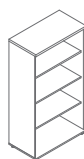

**A4504**  
801 / 432 / 1481  
49 kg



**A5504**  
801 / 432 / 1833  
60 kg

www.mdd.eu



**A6504**  
801 / 432 / 2185  
69 kg



**A3505**  
1000 / 432 / 1129  
51 kg

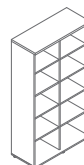

**A5505**  
1000 / 432 / 1833  
77 kg

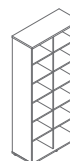

**A6505**  
1000 / 432 / 2185  
89 kg

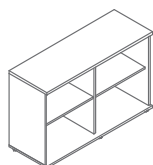

**A2506**  
1200 / 432 / 777  
46 kg



**A3506**  
1200 / 432 / 1129  
57 kg

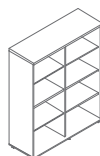

**A4506**  
1200 / 432 / 1481  
62 kg

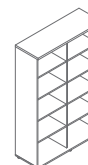

**A5506**  
1200 / 432 / 1833  
86 kg

## Rangements ouverts

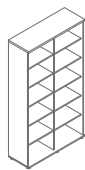

**A6506**  
1200 / 432 / 2185  
101 kg

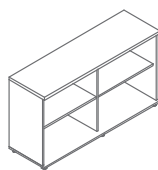

**A2508**  
1600 / 432 / 777  
55 kg

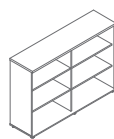

**A3508**  
1600 / 432 / 1129  
73 kg

## Rangements semi-ouverts



**A38P2**  
402 / 432 / 1129  
29 kg



**A58P2**  
402 / 432 / 1833  
41 kg



**A3404**  
801 / 432 / 1129  
42 kg



**A4304**  
801 / 432 / 1481  
60.3 kg

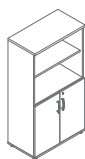

**A4404**  
801 / 432 / 1481  
56 kg

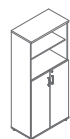

**A5304**  
801 / 432 / 1833  
71.3 kg

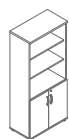

**A5404**  
801 / 432 / 1833  
67 kg

## Rehausse 1 tablette

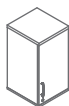

**A16P2**  
402 / 432 / 750  
21 kg

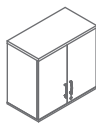

**A1104**  
801 / 432 / 750  
30 kg

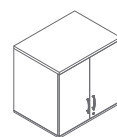

**A1204**  
801 / 600 / 750  
43.5 kg

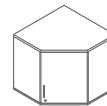

**A1NP4**  
802 / 802 / 750  
50 kg

Rehausse 1 tablette



**A1902**  
402 / 432 / 750  
18 kg

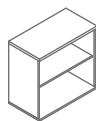

**A1504**  
801 / 432 / 750  
23 kg

Armoire sous photocopieuse

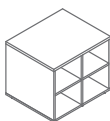

**S85**  
710 / 600 / 600  
32 kg

## Top, base, corps, façade



14 Hêtre \*

26 Aluminium  
satiné31 Chêne  
canadien \*

34 Wengé \*



39 Bouleau clair \*



64 Cacao \*



67 Blanc pastel



106 Noyer \*



154 Anthracite



08 Noir

---

\* corps - groupe II